

Selection Guide

Sivoia QS Triathlon

Residence: _____ Room: _____ Window(s): _____

Step 1 Select Shade Style

Honeycomb

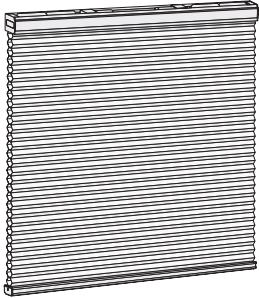

Roller

- Headrail without fascia**
(battery-powered, regular roll shown)



- Regular Roll**
fabric closest to the glass
(standard)

- Reverse Roll**
fabric farthest from the glass
(recommended to clear door or
window hardware)

With fascia

- Fabric-Wrapped**

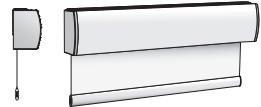

- Architectural**



- Regular Roll**
fabric closest to the glass
(reverse roll not available
with fascia)

Step 2 Select Power

- Battery-powered**

- Plug-in**

- Power Panel**

- Manual shade**

Step 3 Select Control

System

- Keypad**



Timeclock

- Mobile device**

- Pico**

- Third-party integration**

Standalone

- Pico**
for controlling a single
shade or multiple shades
with one button press.

- 4-group RF**
for assigning a group of shades
to each of the four group
buttons on the remote.

Please note: Product options may vary depending on application and intended use. For more technical information, reference www.lutron.com or work with your qualified Lutron provider. Product availability is subject to change.

Step 4

Shade Mount and Measurements (choose one)

- Inside Mount** enter window measurements below;
if full recess is desired, check the projection dimension of your shade type

Width:

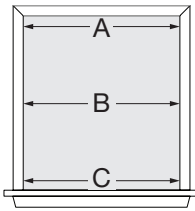

A _____ inches/mm

B _____ inches/mm

C _____ inches/mm

Smallest width: _____ inches/mm

Height:

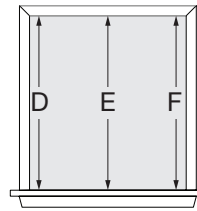

D _____ inches/mm

E _____ inches/mm

F _____ inches/mm

Smallest width: _____ inches/mm

Honeycomb shade projection full-recess depth for inside mount

Battery powered
Tap 'n' Tilt brackets

2½ in
(64 mm)

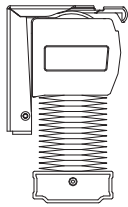

Manual shade
Stationary brackets

2 in
(51 mm)

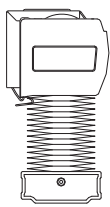

Roller shade projection full-recess depth for inside mount

Without Fascia*
(battery powered)

3 in
(76 mm)



(wired power)

3 in
(76 mm)

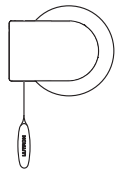

(cordless manual)

3 in
(76 mm)

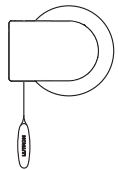

Fabric-Wrapped Fascia

3⅞ in
(86 mm)

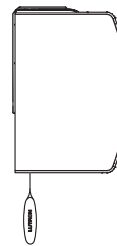

Architectural Fascia

3⅞ in
(86 mm)

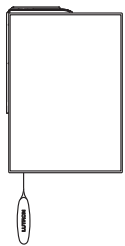

* Without fascia, the projection varies with the size of the fabric roll-up (fabric panel height). The dimension shown is based on the largest available fabric panel height; the **maximum** projection.

- Outside Mount** enter width and height below

On Trim **Above Trim**** (includes spacers to clear trim up to 1/2" (13 mm) thick)

Width: Enter the width of the area you want the fabric to cover _____ inches/mm

Height: Enter the distance from the top of the headrail to the window sill _____ inches/mm

** When mounting above trim, the top of the headrail must be at least 3⅞" (80 mm) (honeycomb), or 4½" (114 mm) (roller) above the top edge of the window trim.

Step 5

Select Fabric

Utilize the insulating Honeycomb or Roller Essentials fabric binder or visit www.lutron.com/fabrics

Fabric P/N: _____

For more information, please download the Lutron Fabric Collections mobile app.

Step 6

Honeycomb Shade Enhancements

Back Cover

A cover on the back of the headrail eliminates any light that may come through the mounting area (typically used only on room darkening, inside mount applications).

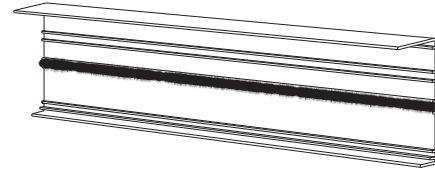

Cable-Guided

(outside mount only)

Select this if you are mounting a shade to a door.

Choose anchor and matching hardware color:

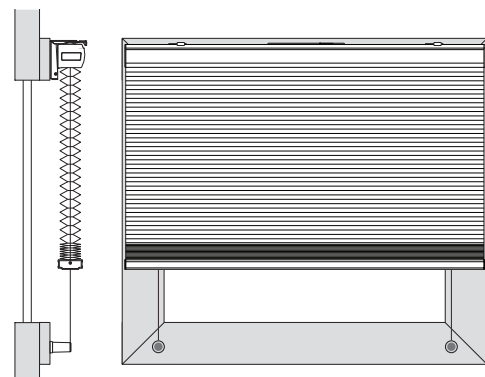
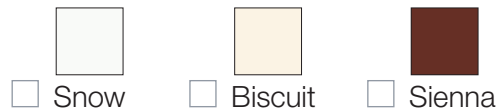

For more information, please visit www.lutron.com or call **1 (800) 446-1503**

www.lutron.com



World Headquarters 1.610.282.3800

24/7 Technical Support 1.800.523.9466

Customer Service 1.888.LUTRON1 (1.888.588.7661)

